

AMERISPAN

BY EVENTEC

AS120 9m (30') Width, 3m Leg Standard Structure

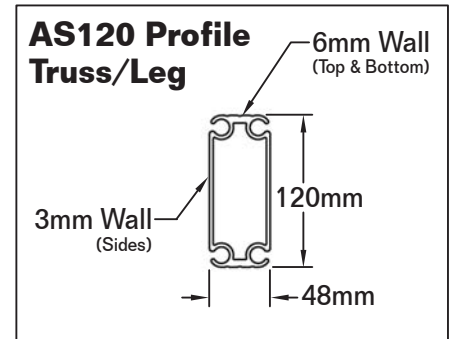
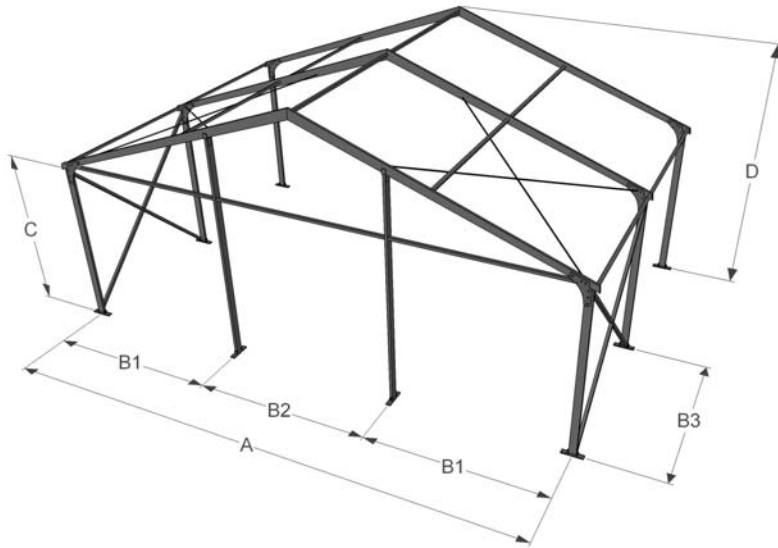

Dimensions and Technical Specifications

All Dimensions On Center

(A) Width	9.02m	29.61ft
(B1) Gable Leg Distance	3.01m	9.88ft
(B2) Gable Leg Distance	3.00m	9.85ft
(B3) Truss/Leg Distance	3.00m	9.84ft
(C) Eave Height	2.96m	9.72ft
(D) Ridge Height	4.63m	15.19ft

Not Compatible with Glasswall or Hardwall Systems

Roof Slope	20 degrees
------------	------------

Extruded Aluminum Parts

Hollow, Tracked Profile Shown Above
6061 T-6 Aluminum
Clear Anodized 204-R1 Finish

Steel Parts

A36 Structural Steel
A572 Grade 50 for Leg Reinforcement Plates
Hot-Dip Galvanized for Corrosion Resistance

AS120 X-Bracing

One 3m Bay Containing X-Bracing and Rafter
Cables Can be Followed with Up To Five
Open 3m Bays Without X-Braces or Cables

*Technical specifications may change at any time
without notice. ©2012 Eventec

Available Exclusively From:



LEADERS IN INNOVATIVE EVENTS