

# AMERISPAN

BY EVENTEC

## AS120 3m (10') Width, 3m Leg Standard Structure

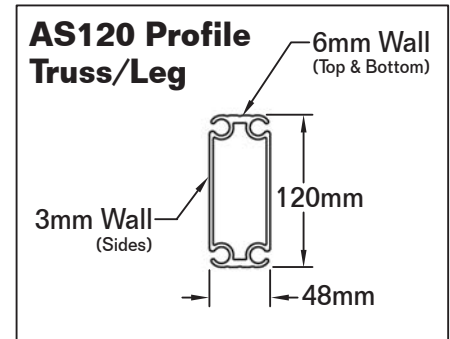
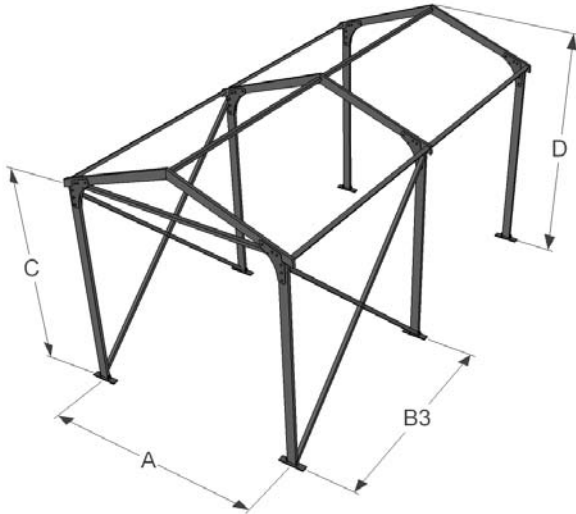

### Dimensions and Technical Specifications

#### All Dimensions On Center

(A) Width	3.02m	9.91ft
(B3) Truss/Leg Distance	3.00m	9.84ft
(C) Eave Height	2.96m	9.72ft
(D) Ridge Height	3.54m	11.61ft

#### Not Compatible with Glasswall or Hardwall Systems

Roof Slope	20 degrees
------------	------------

#### Extruded Aluminum Parts

Hollow, Tracked Profile Shown Above  
6061 T-6 Aluminum  
Clear Anodized 204-R1 Finish

#### Steel Parts

A36 Structural Steel  
A572 Grade 50 for Leg Reinforcement Plates  
Hot-Dip Galvanized for Corrosion Resistance

#### AS120 X-Bracing

One 3m Bay Containing X-Bracing and Rafter  
Cables Can be Followed with Up To Five  
Open 3m Bays Without X-Braces or Cables

\*Technical specifications may change at any time  
without notice. ©2012 Eventec

Available Exclusively From:



LEADERS IN INNOVATIVE EVENTS